

94 MAGNUM WIPER DELAY

12V B+
FB1-7
FRONT
FIREWALL
20 A

REL
RY-1
N.C.

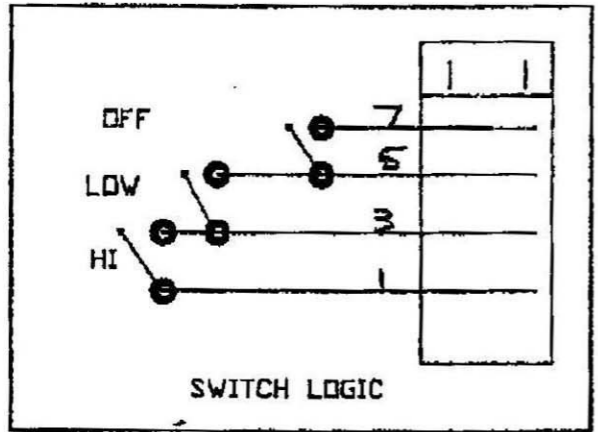

SWF 511.048

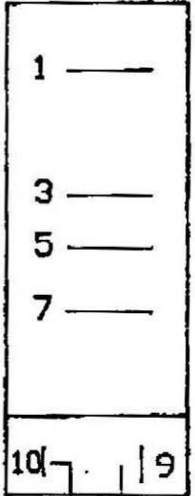

HI, BLUE
BATT, RED
LO, BROWN
PARK, BLACK
GROUND, WHITE

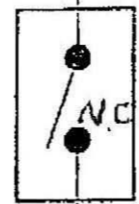
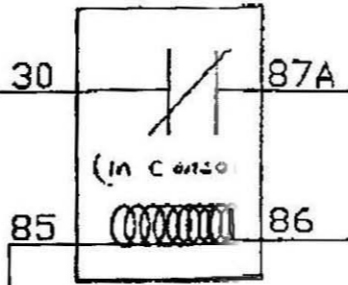

DELAY SWITCH
SWF 511.005

(D. set
app 2 1/2 Sec)

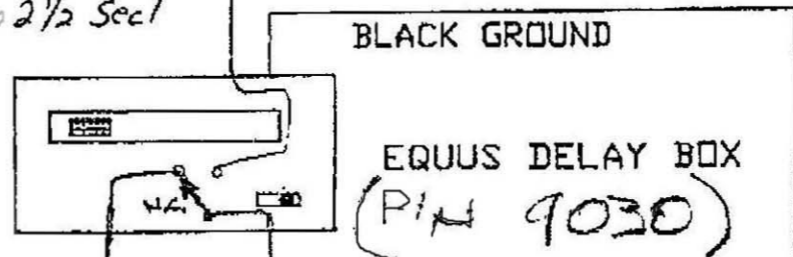

RE WHITE

NOTE 1

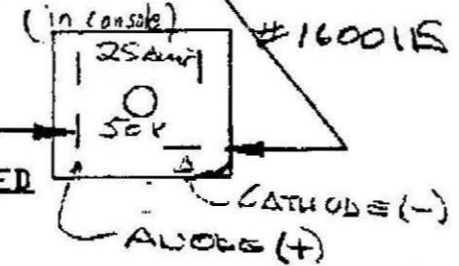

NOTE 1
USE SILICON BRIDGE
AS A BLOCKING DIODE
SEE EXAMPLE AT RT
POLARITY MUST BE

VIOLET, B+

BLACK GROUND

WHITE

LD

HI

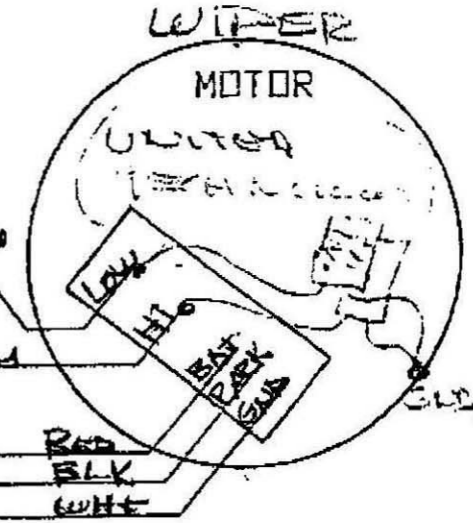

SAFARI MOTOR COACHES, INC.		DATE	6-23-93
CONT. WIPER DELAY		DRAWN BY	SDB
SCALE	NONE	DATE	SE/01